

bluecube<sup>3</sup>

press & media







bluecube produces a range of media solutions that are designed to meet the following venue requirements -

- Permanent - media areas - installed with fixed desks that accommodate a set number of seat positions.
- Temporary media areas - installed with a set number seats which can be quickly and easily 'changed out' to accommodate desks.
- Flexible - media areas- installed with a set number of seats and writing tablet arms which can be used as either general admission seating or as media positions.

## layout requirements

- Min row depth (**RD**) requirement 1200mm
- Min average seat spacing (**SC**) 650mm

## features

- 460mm desk top depth (**DD**)
- Continuous row installation (without intermittent egress steps)
- Optional modesty panel
- Automatic seat return

# Permanent Desk – Low Density



**DD** – desk depth  
460mm

**DW** – desk width  
1300mm

**SC** – seat centres  
Average 650mm

**DEO** – desk envelope open  
980mm

**DEC** – desk envelope closed  
630mm

**SH** – seat height  
450mm

**CW** – clearway  
dependant on  
row depth

**RD** – row depth  
min 1200mm

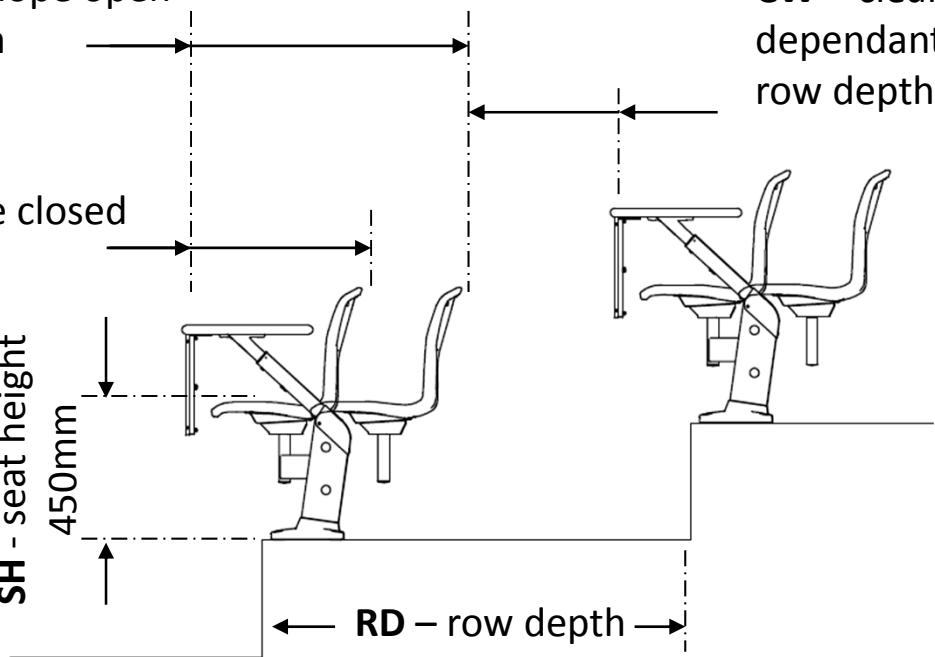
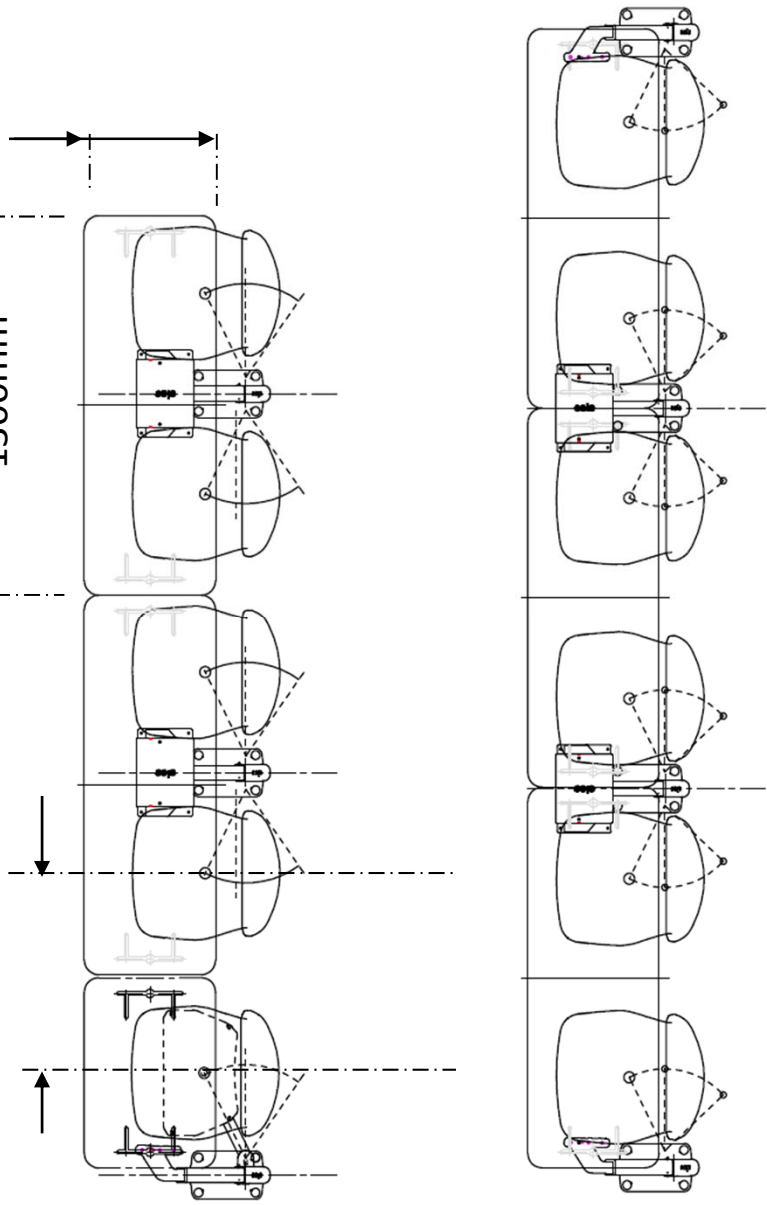

## layout requirements

- Min row depth (**RD**) requirement 800mm
- Min seat spacing (**SC**) 550mm

## Features

- 350mm desk top depth (**DD**)
- Requires egress steps (every 2 seat places)
- Optional modesty panel

# Permanent Desk – Mid Density

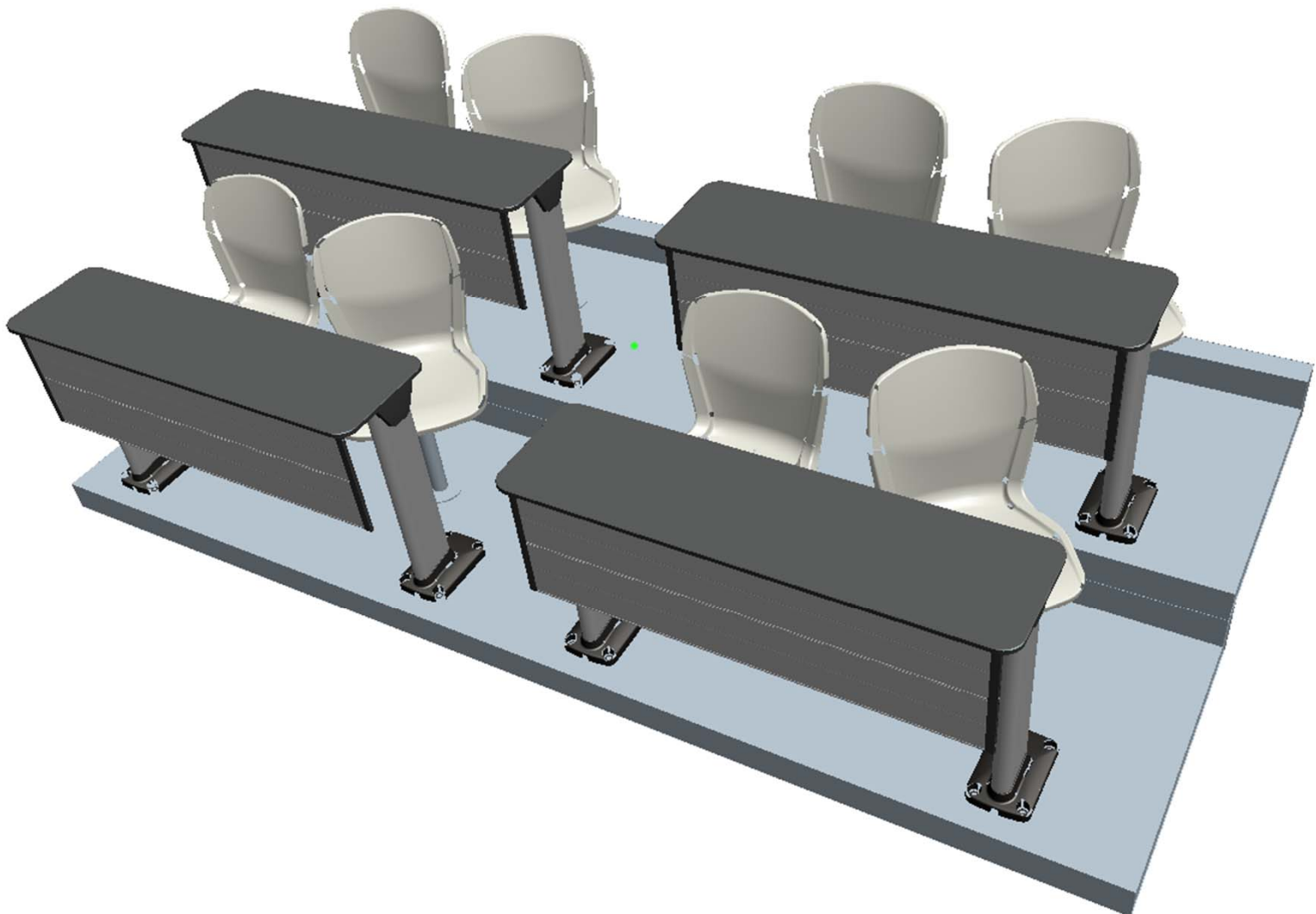

**DD** – desk depth

350mm

**DW** – desk width

1300mm

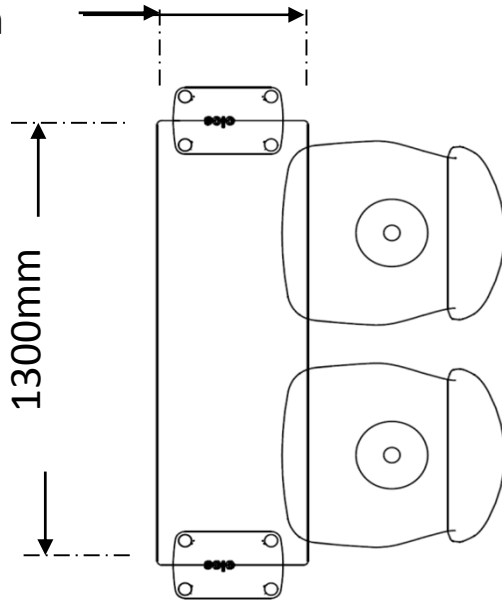

egress steps

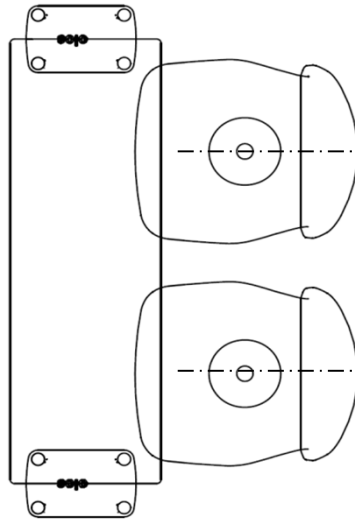

**SC** – seat centres  
Min. 550mm



egress steps

**SH** – seat height

450mm

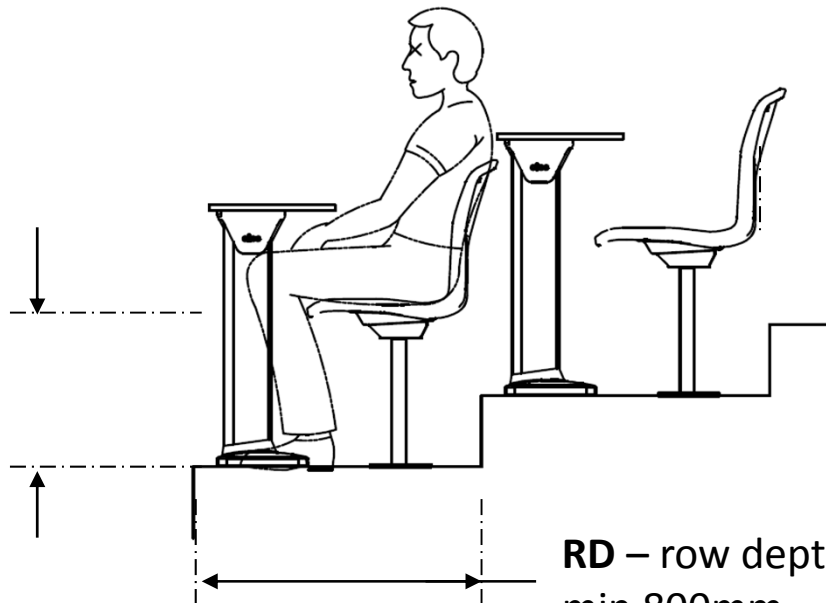

**RD** – row depth  
min 800mm



egress steps

## layout requirements

- Min row depth requirement **(RD)** 1200mm
- Min seat spacing **(SC)** 550mm

## Features

- 350mm desk top depth **(DD)**
- Continuous row installation (without intermittent egress steps)
- Optional modesty panel

# Permanent Desk – High Density





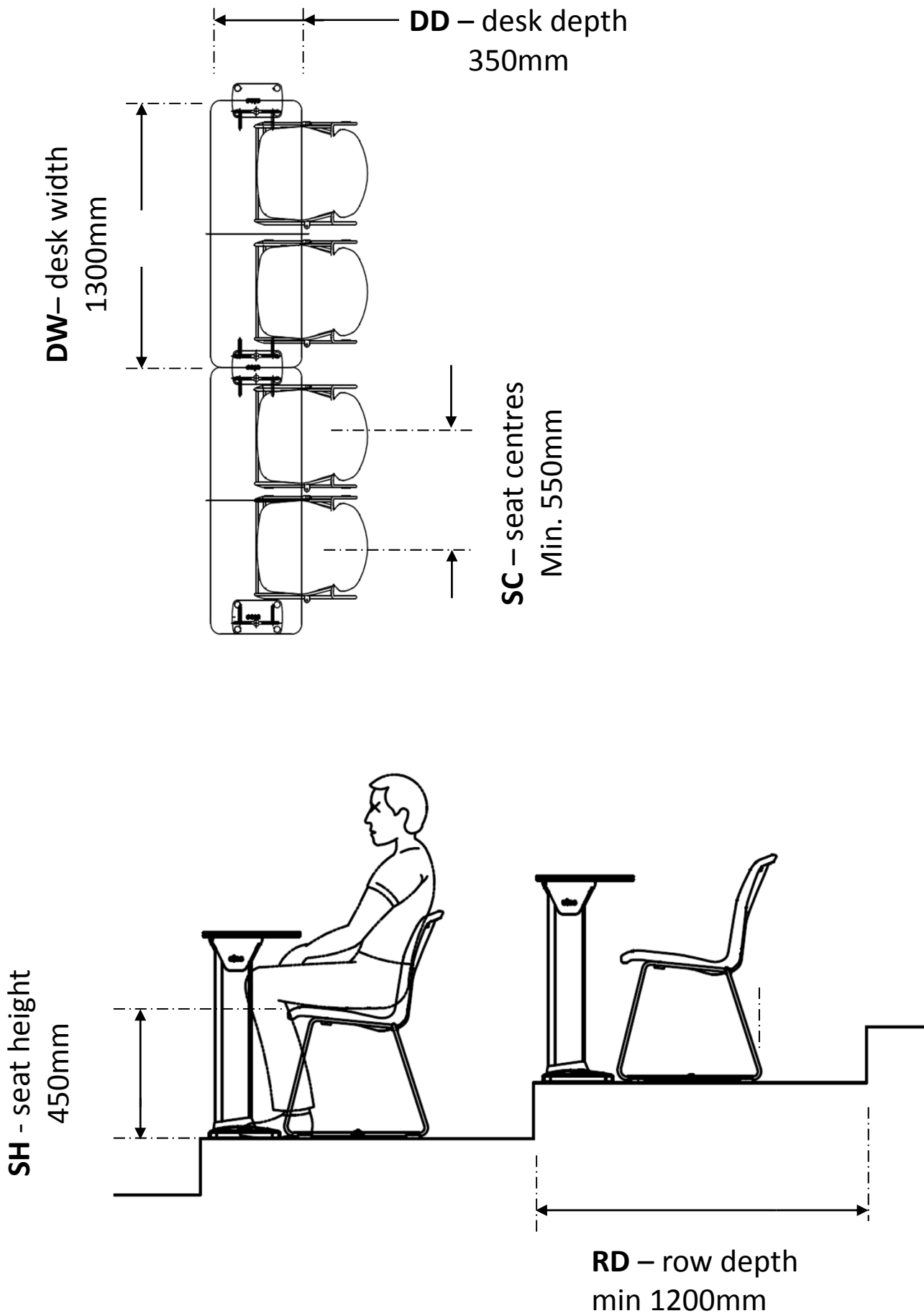

## layout requirements

- Min row depth requirement (**RD**) 750mm
- Min seat spacing (**SC**) 500mm

## Features

- Choice of self tipping seat model
- Requires egress steps (every 2 seat places)
- Easy conversion to GA seating

# Temporary Desk

Typical layout shown in media mode

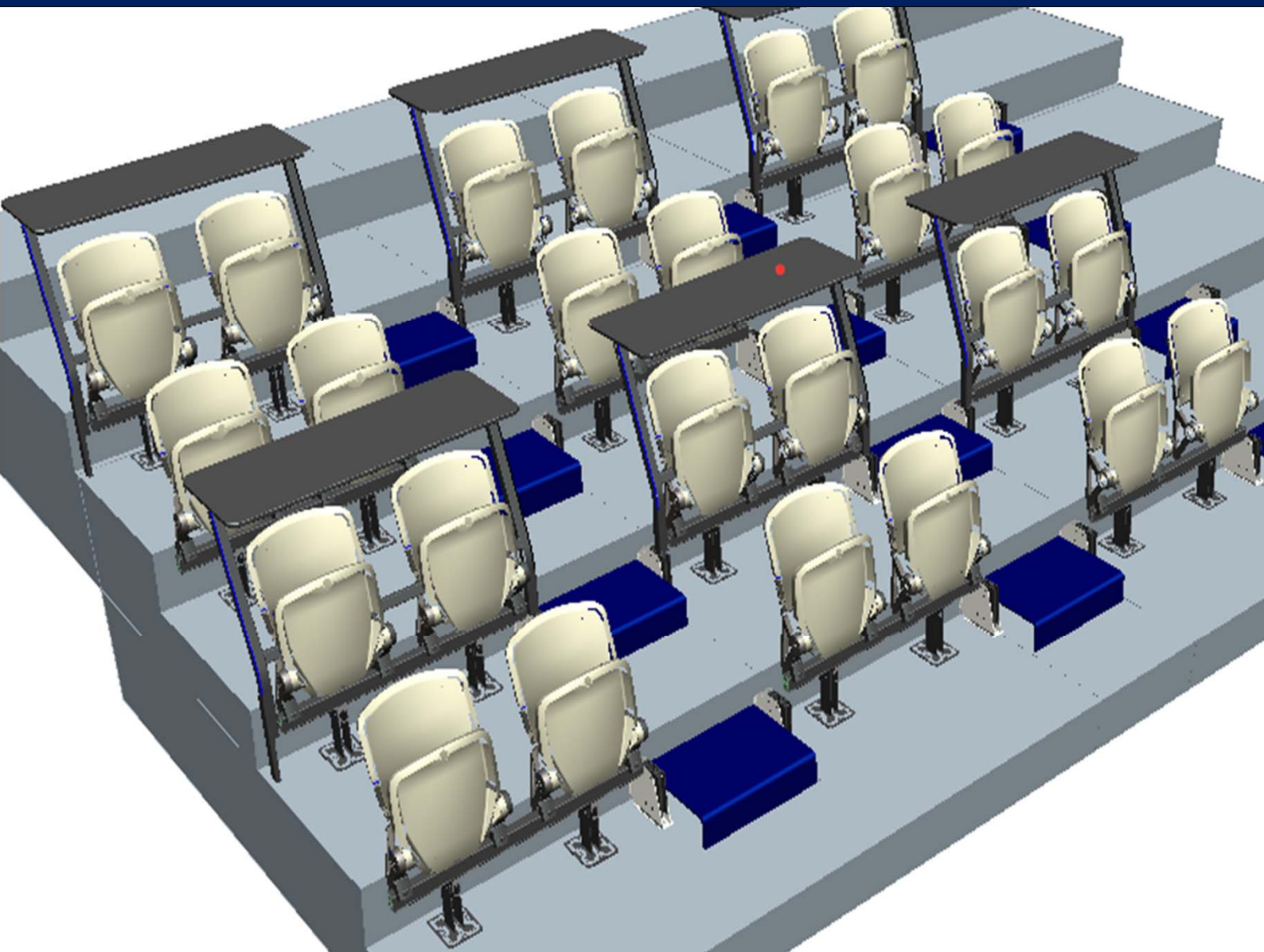

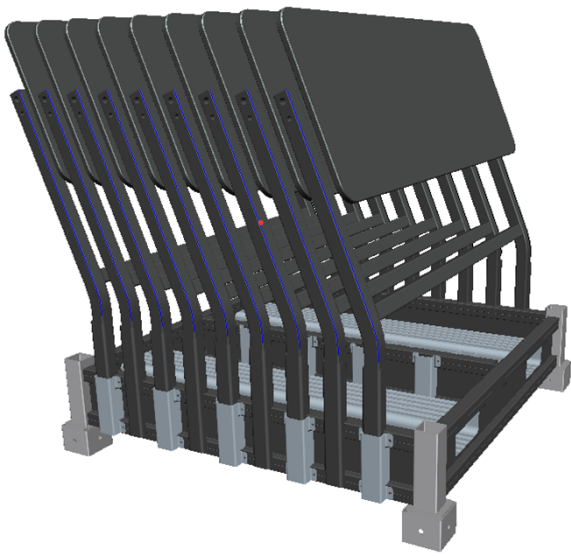

Light weight (25Kg) aluminium storage stillages are available for storage of the desk and seat units when they are removed from the layout.

Typical layout shown in seating mode

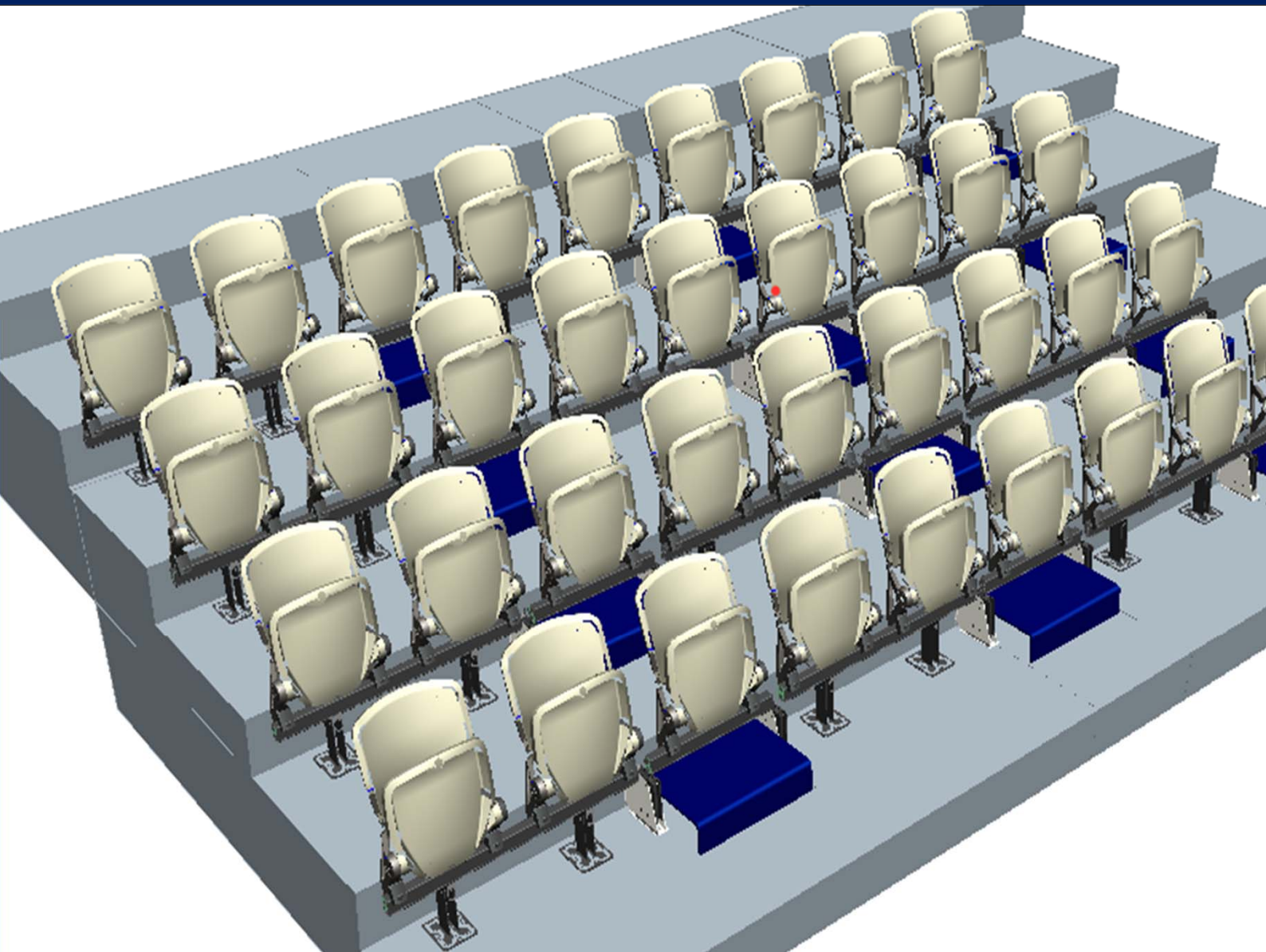

## Step 1

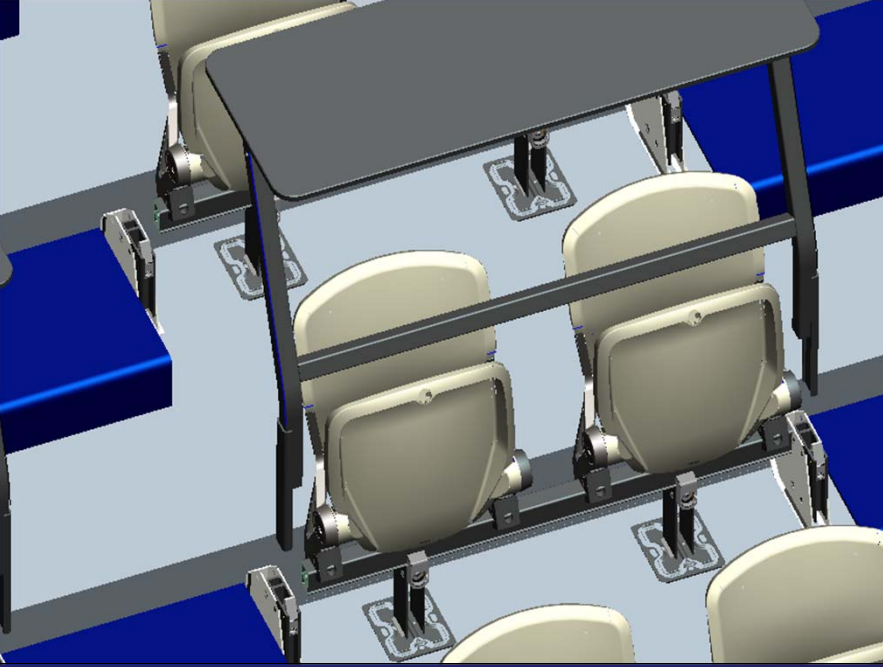

**fast – latch** mechanisms make changing over from a media to an all seated set up quick and easy – the area is arranged 2 & 1 seat modules.

Changeover sequence from media to full seated general admission & vice versa.

- Step 1 - Remove desks from the **fast – latch** system.
- Step 2 - Plug in the single seat modules into the **fast – latch** system to infill the intermittent egress steps.

## Step 2



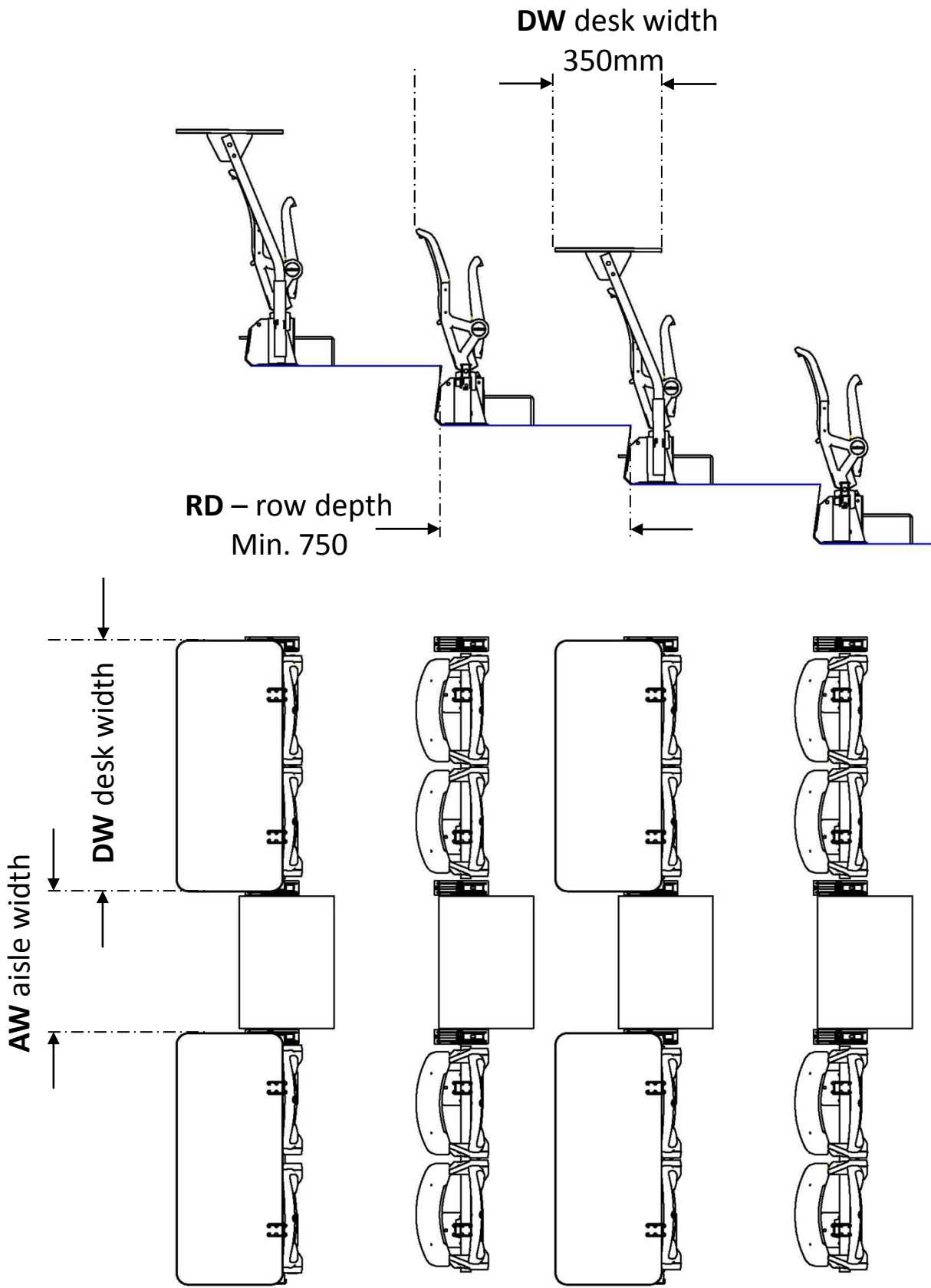

DW desk width

350mm

RD - row depth  
Min. 750

AW aisle width

DW desk width

## layout requirements

- Min row depth requirement 800mm
- Min average seat spacing 550mm

## Features

- Continuous row installation ( without intermediate egress steps)
- Seats can be used as GA seats without re-configuration

# Flexible media areas





If the requirement is more flexibility than a permanent desk **scribe** folding tablet arms allow the media area to be sold as general admission then the tablet is in 'stowed' position – refer to the **scribe** product sheet for full detail.

Power and data can be provided at each position by the addition of an electrical conduit running the entire length of the row.

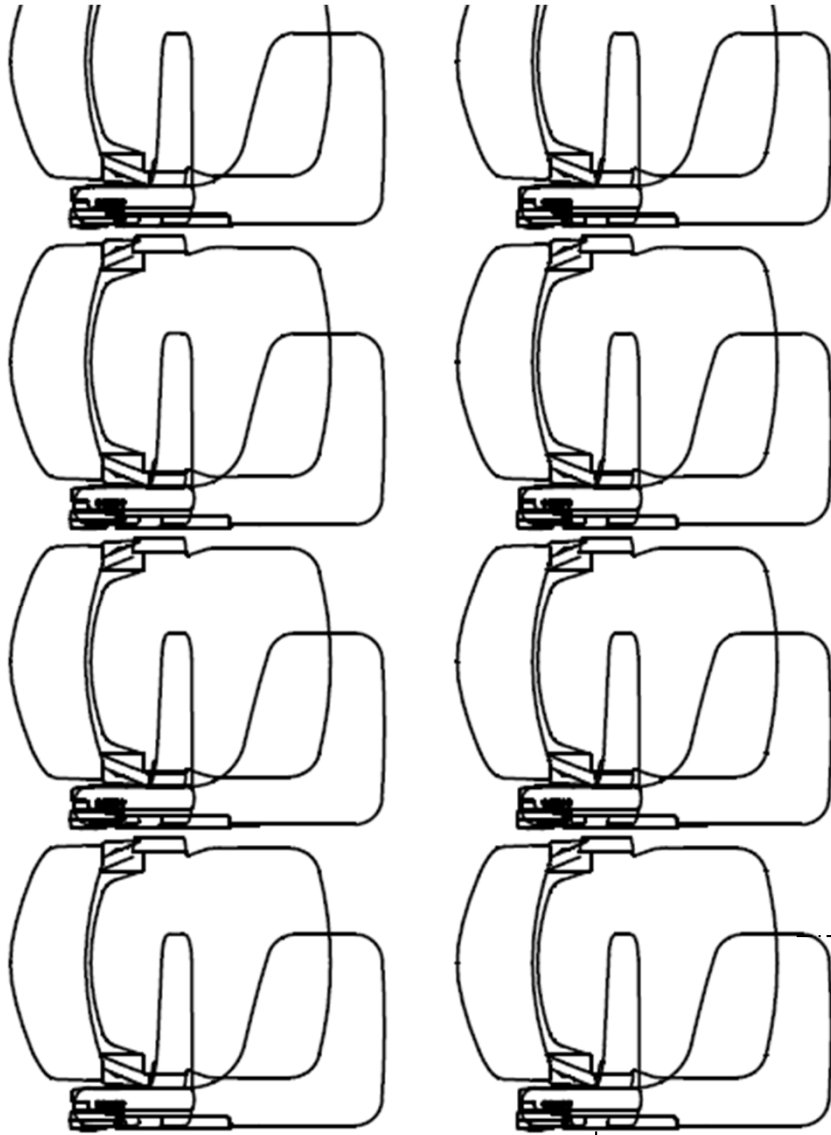

**tablet width**  
350mm

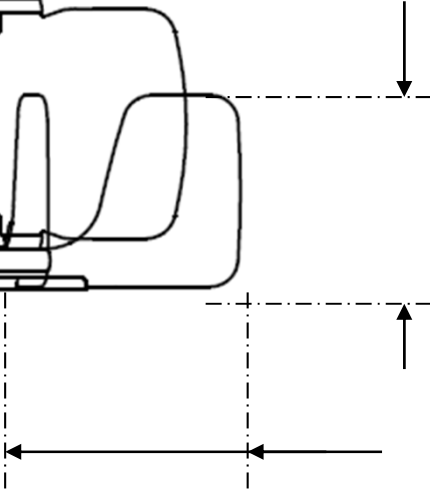

**tablet depth**  
560mm

